

**3.44 IN./135MM
TORPEDO DIA.**

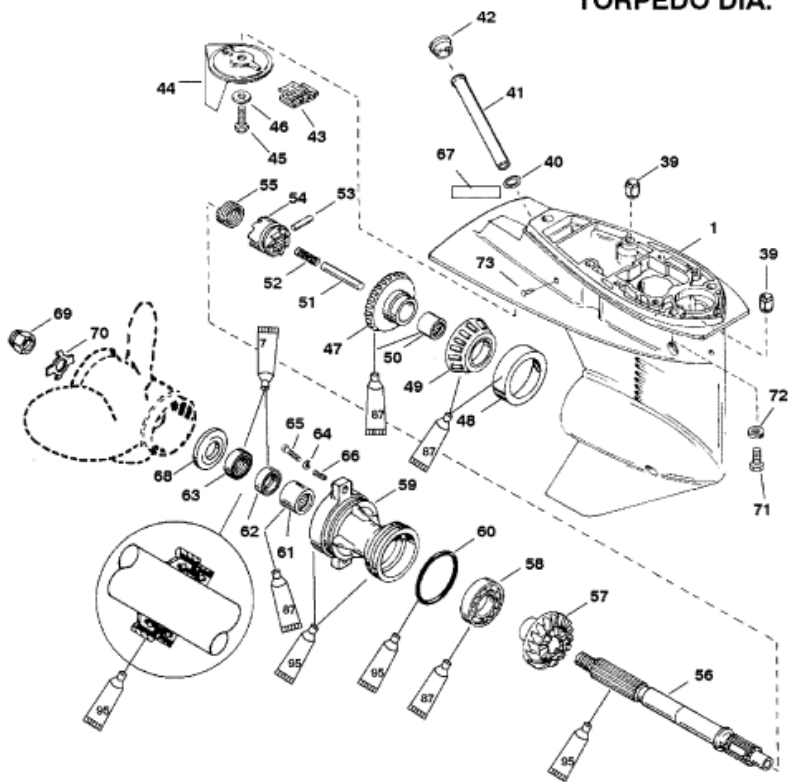

-  Loctite 271 (92-806820)
-  Quicksilver Gear Lubricant (92-19007A24)
-  Anti-Corrosion Grease (92-78376A6)
-  2-4-C w/Teflon (92-825407A12)

Parts List

Ref	Class	Part	Description	Qty	Comment	Footnote
-	1682	821306T30	GEAR HOUSING	1	(SHORT) (BLACK)	
-	1682	821306T31	GEAR HOUSING	1	(SHORT) (GRAY)	
-	1682	821306T32	GEAR HOUSING	1	(LONG) (BLACK)	
-	1682	821306T33	GEAR HOUSING	1	(LONG) (GRAY)	
1	1682	821306T12	GEAR HOUSING	1	(BASIC) (BLACK)	
1	1682	821306T13	GEAR HOUSING	1	(BASIC) (GRAY)	
39	17	821327	DOWEL PIN	2		
40	27	823942	GASKET WATER TUBE	1		
41	32	821828	TUBE	1		
42	19	824928	PLUG-RUBBER	1		
43		821829	SCREEN-WATER INLET	1		
44		822157T 2	TRIM TAB	1		
45	10	824970 20	SCREW (M8 X 20)	1		
46	12	72397	WASHER	1		
47	43	833000A 2	FORWARD GEAR ASSEMBLY (2	1		
48	31	99328A 1	ROLLER BEARING ASSY.	1		
49		NSS	CUP	1		
50	31	41326	ROLLER BEARING	1		
51		821578	FOLLOWER-CAM	1		
52	24	826199 1	SPRING	1		
53	17	85093	PIN-CROSS	1		
54	52	821314T	CLUTCH	1		
55	24	38114	SPRING	1		
56	44	821577 2	PROPELLER SHAFT	1		
57	43	833001T	REVERSE GEAR (29 TEETH)	1		
58	30	20839T	BALL BEARING	1		
59		19291A 3	BEARING CARRIER	1		
60	25	815460	O RING	1		15
61	31	21700	NEEDLE BEARING	1		
62	26	69188	OIL SEAL	1		15
63	26	69189	OIL SEAL	1		15
64	12	855941	WASHER	2		
65	10	855940 30	SCREW (M8 X 25 - CAP SCREW)	2		
66		822773 1	THREADED INSERT	2		
67		NSS	DECAL (2.42:1)(12 X 29)	1		
68		73345A 1	THRUST HUB	1		
69	11	69578Q 1	PROP NUT KIT	1		
70	14	76281	TAB WASHER	1		
71	10	40003 80	SCREW	4		
72	12	856774	WASHER	4		
73	19	95925	PLUG	1		